

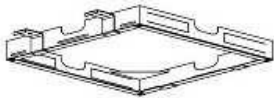

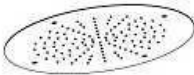





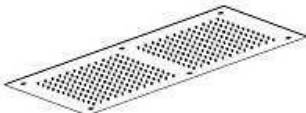

E044096B



	E044048	E044047	E044046	E044024	E044067	E044096	E044088	E044059
	X1	X1	X1	X1	X1	X1	X1	X1
	X1	X1	-	-	-	-	-	-
	-	-	X1	X1	X1	-	-	-
	-	-	-	-	-	X1	-	-
	-	-	-	-	-	-	X1	X1
	X2	X2	X2	X2	X4	X2	X2	X2
	X1	X1	X1	X1	X2	X1	X1	X1
	X4	X4	X4	X4	X9	X4	X6	X6
	-	-	-	-	X1	-	-	-
 Montážní návod	X1	X1	X1	X1	X1	X1	X1	X1

- Tento spotřebič musí být správně nainstalován odbornou firmou v souladu s platnými zákony.
- Případná oprava musí být provedena pouze odbornou firmou.

Výrobce odmítá jakoukoli odpovědnost v případě nedodržení výše uvedené povinnosti

E044048

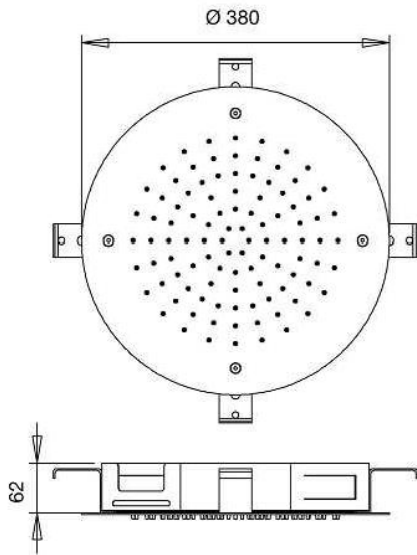

Průtok sprchy L/min



Minimum 1 Bar
Maximum 5 Bar
Optimum 3 Bar

Maximální 70°C
Optimální 38°/40°C

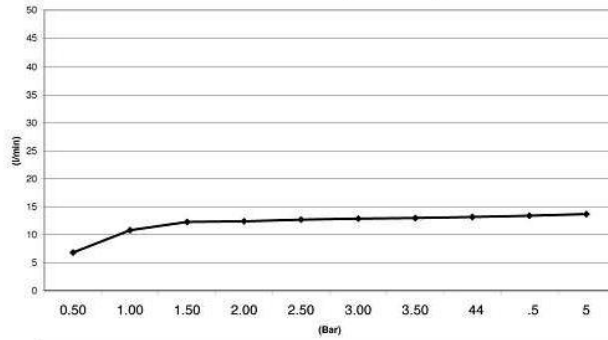

Pressione Dinamica (bar) / Portata (Litri/min)	
Bar	0,50 1,00 1,50 2,00 2,50 3,00 3,50 4 4,5 5
Flow Rate (l/min)	6,8 10,8 12,3 12,4 12,7 12,9 13 13,2 13,4 13,7

E044047

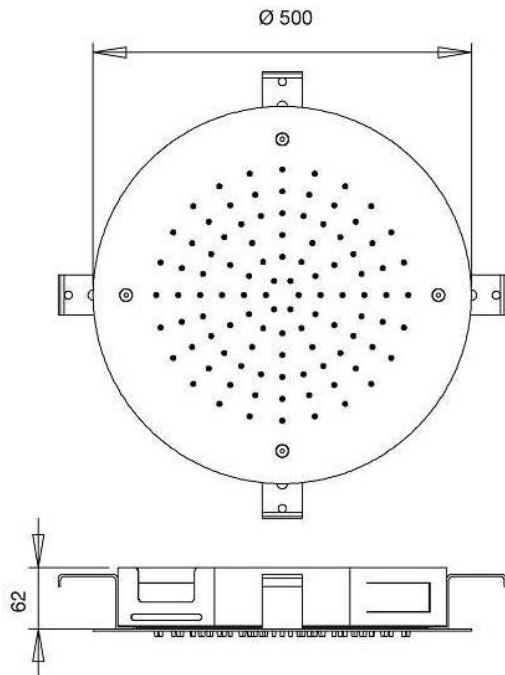

Průtok sprchy L/min



Minimum 1 Bar
Maximum 5 Bar
Optimum 3 Bar

Maximální 70°C
Optimální 38°/40°C

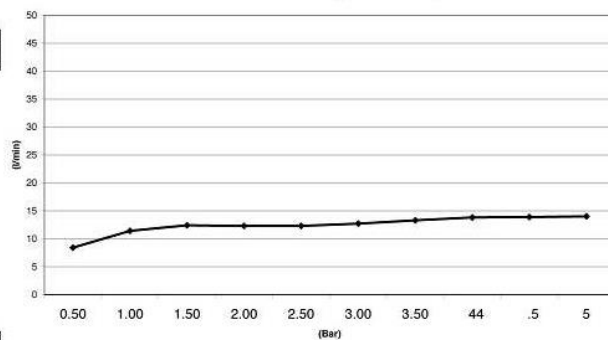

Pressione Dinamica (bar) / Portata (Litri/min)	
Bar	0,50 1,00 1,50 2,00 2,50 3,00 3,50 4 4,5 5
Flow Rate (l/min)	8,4 11,4 12,4 12,3 12,3 12,7 13,3 13,8 13,9 14

E044046 |

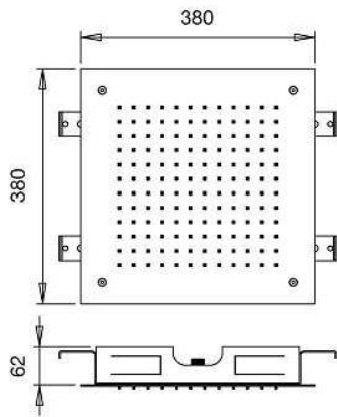

Průtok sprchy L/min



Minimum 1 Bar
Maximum 5 Bar
Optimum 3 Bar



Maximální 70°C
Optimální 38°/40°C

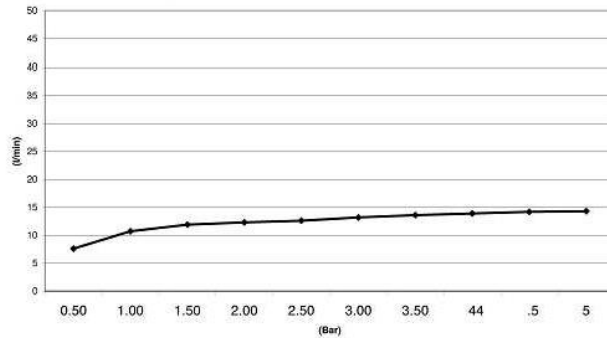

	Pressione Dinamica (bar) / Portata (Litri/min)									
Bar	0,50	1,00	1,50	2,00	2,50	3,00	3,50	4	4,5	5
—●—	7,6	10,7	11,9	12,3	12,6	13,2	13,6	13,9	14,2	14,3

E044024 |

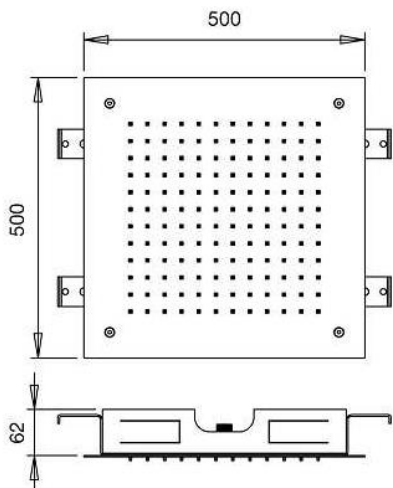

Průtok sprchy L/min



Minimum 1 Bar
Maximum 5 Bar
Optimum 3 Bar



Maximální 70°C
Optimální 38°/40°C

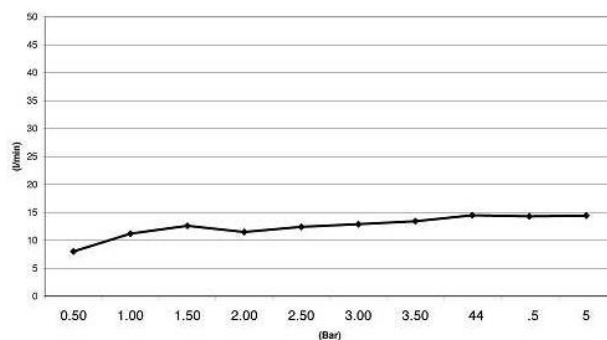

	Pressione Dinamica (bar) / Portata (Litri/min)									
Bar	0,50	1,00	1,50	2,00	2,50	3,00	3,50	4	4,5	5
—●—	8	11,2	12,6	11,5	12,4	12,9	13,4	14,5	14,3	14,4

| E044067 |

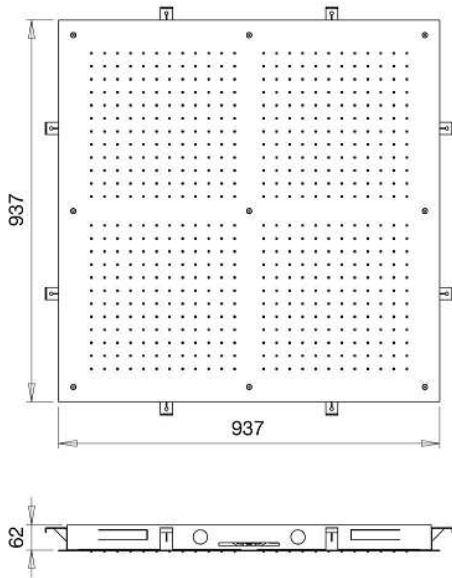

Průtok sprchy L/min



Minimum 1 Bar
Maximum 5 Bar
Optimum 3 Bar

Maximální 70°C
Optimální 38°/40°C

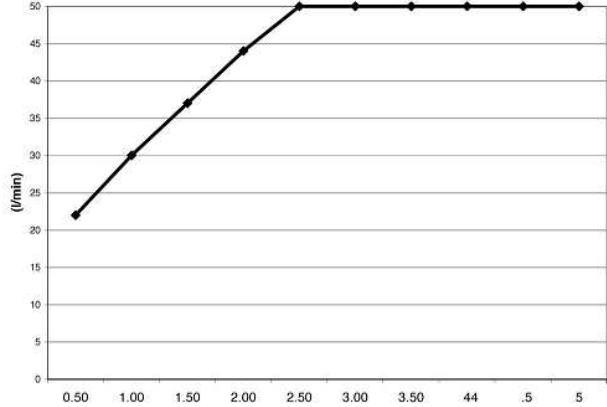

(Bar)		Pressione Dinamica (bar) / Portata (Litri/min)									
Bar		0,50	1,00	1,50	2,00	2,50	3,00	3,50	4	4,5	5
—●—		22	30	37	44	50	50	50	50	50	50

| E044096 |

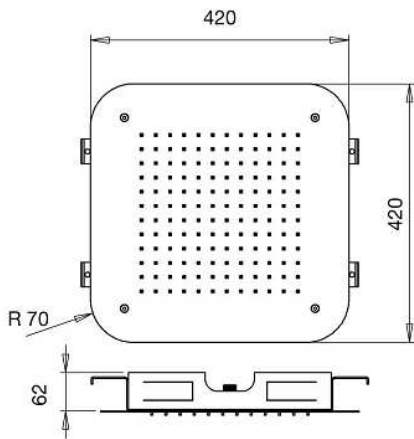

Průtok sprchy L/min



Minimum 1 Bar
Maximum 5 Bar
Optimum 3 Bar

Maximální 70°C
Optimální 38°/40°C

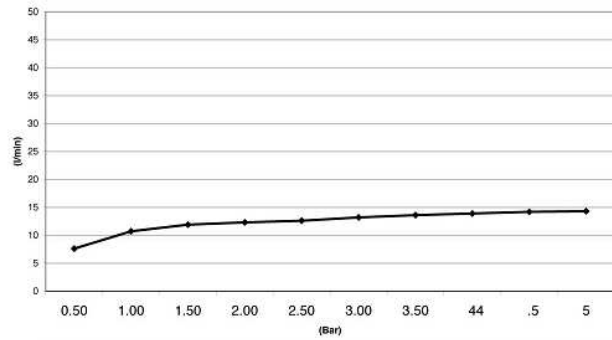

(Bar)		Pressione Dinamica (bar) / Portata (Litri/min)									
Bar		0,50	1,00	1,50	2,00	2,50	3,00	3,50	4	4,5	5
—●—		7,6	10,7	11,9	12,3	12,6	13,2	13,6	13,9	14,2	14,3

E044088

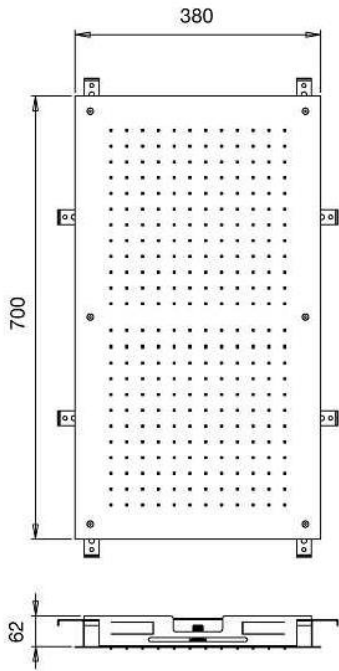

Průtok sprchy L/min



Minimum 1 Bar
Maximum 5 Bar
Optimum 3 Bar

Maximální 70°C
Optimální 38°/40°C

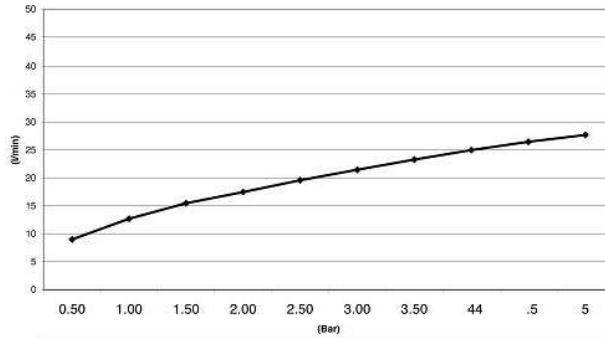

	Pressione Dinamica (bar) / Portata (Litri/min)									
Bar	0,50	1,00	1,50	2,00	2,50	3,00	3,50	4	4,5	5
—●—	9	12,7	15,5	17,5	19,6	21,5	23,3	25	26,5	27,7

E044059

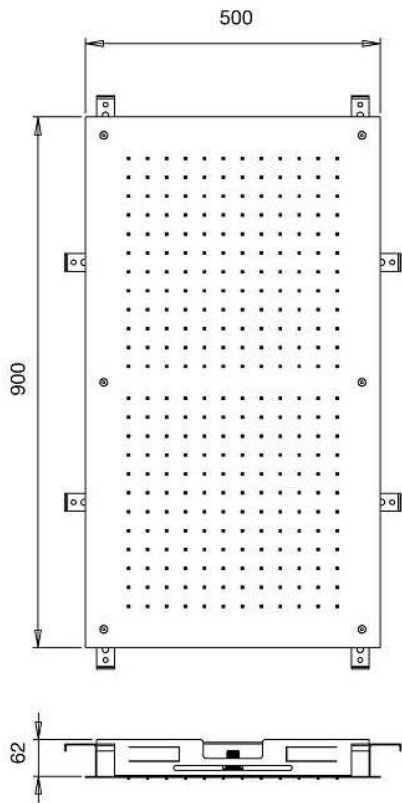

Průtok sprchy L/min



Minimum 1 Bar
Maximum 5 Bar
Optimum 3 Bar

Maximální 70°C
Optimální 38°/40°C

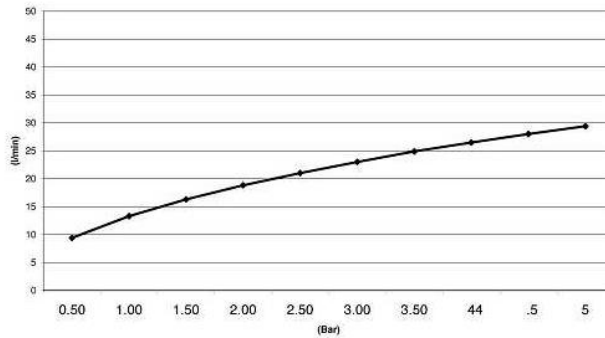

	Pressione Dinamica (bar) / Portata (Litri/min)									
Bar	0,50	1,00	1,50	2,00	2,50	3,00	3,50	4	4,5	5
—●—	9,4	13,3	16,3	18,8	21	23	24,9	26,5	28	29,4

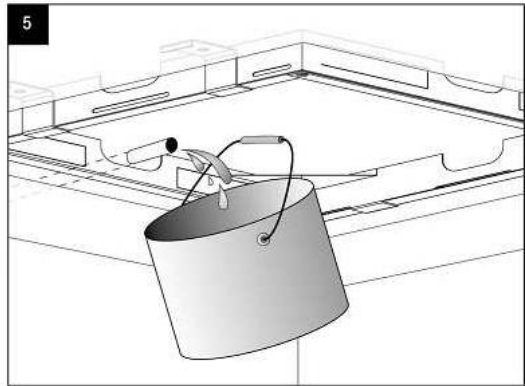
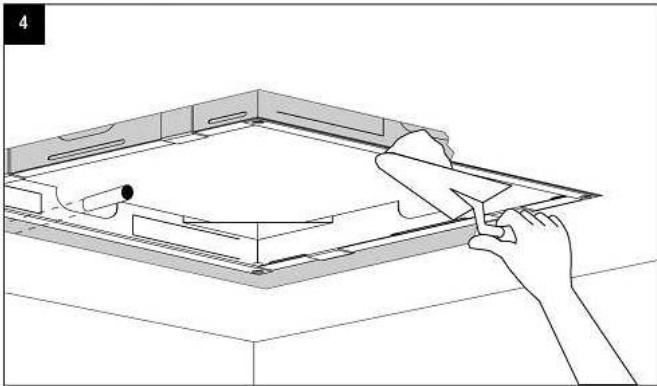
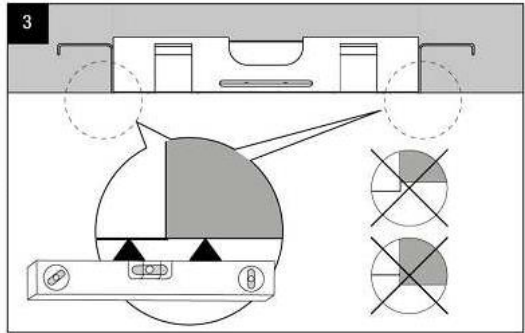
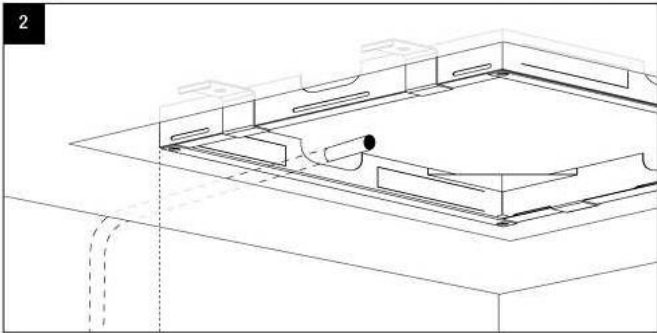
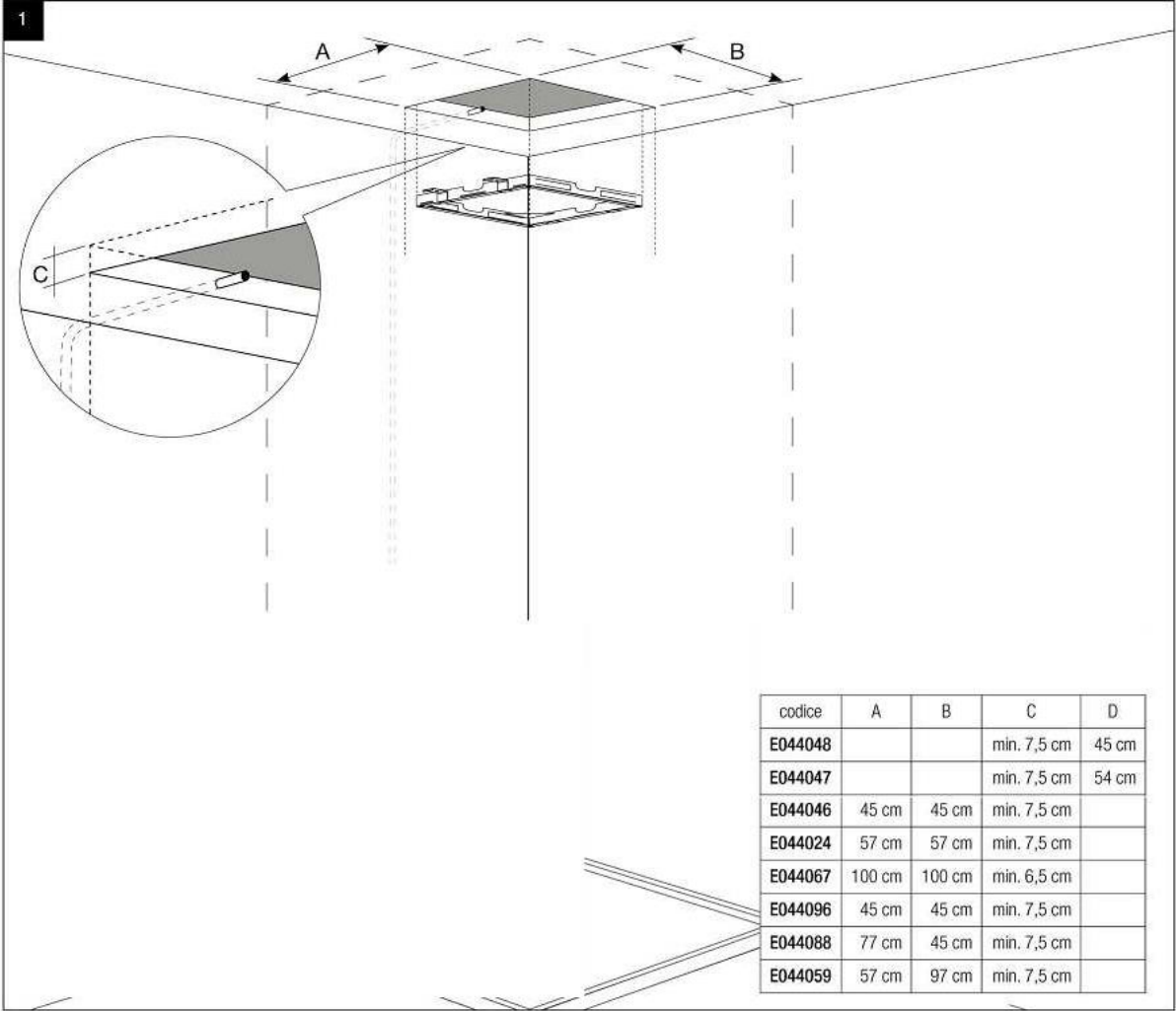

6

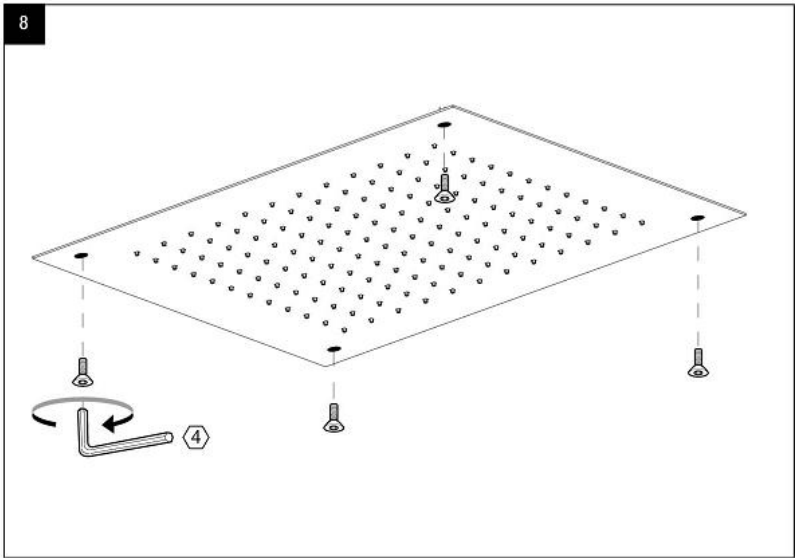
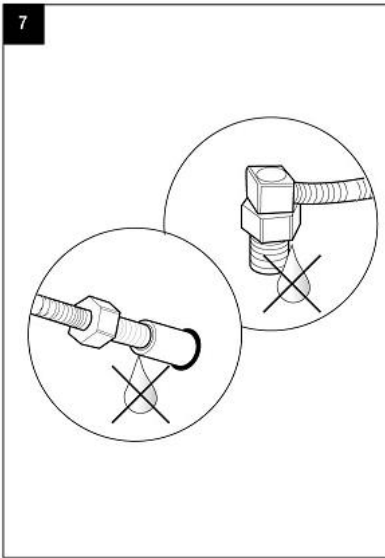
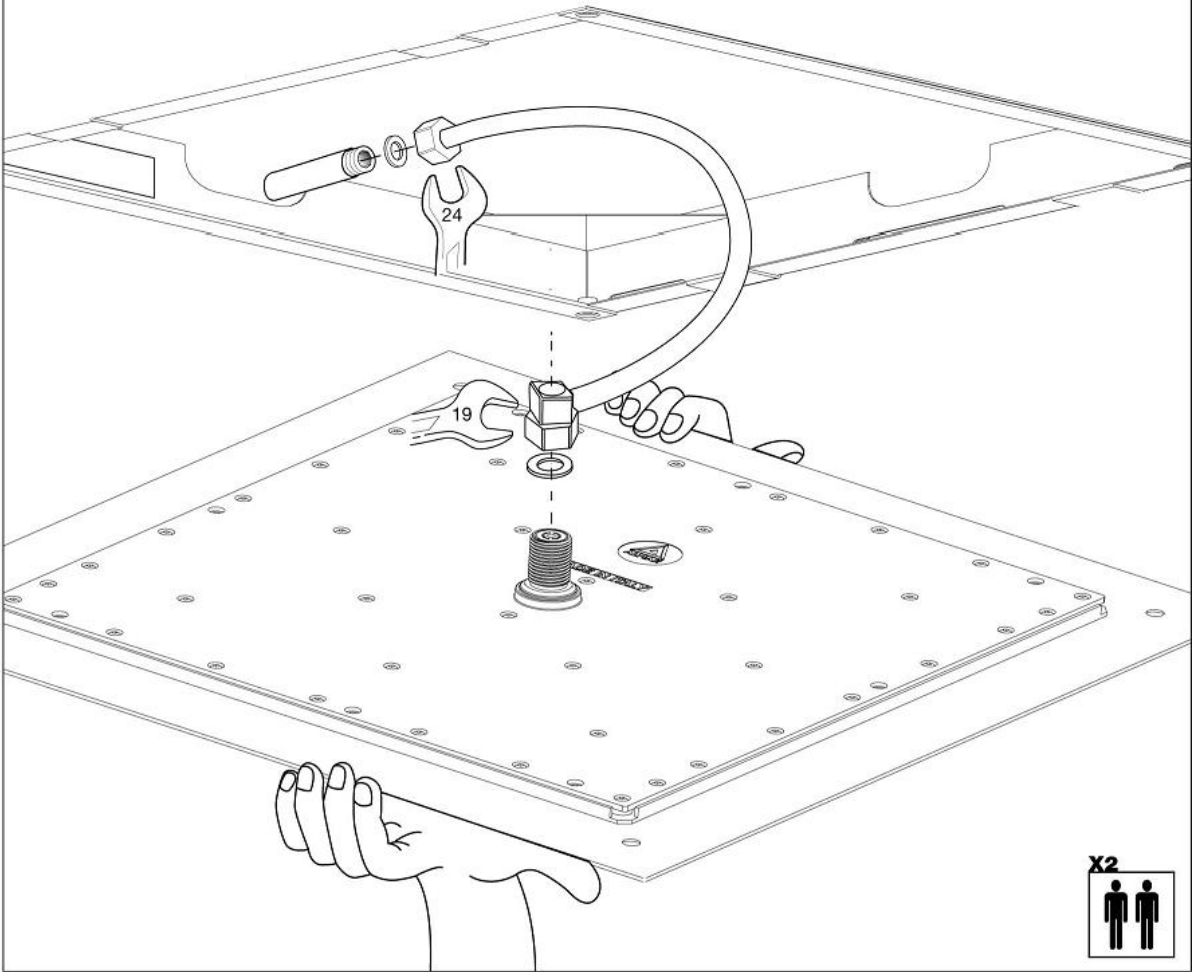

Cleaning



Čištění sprchy

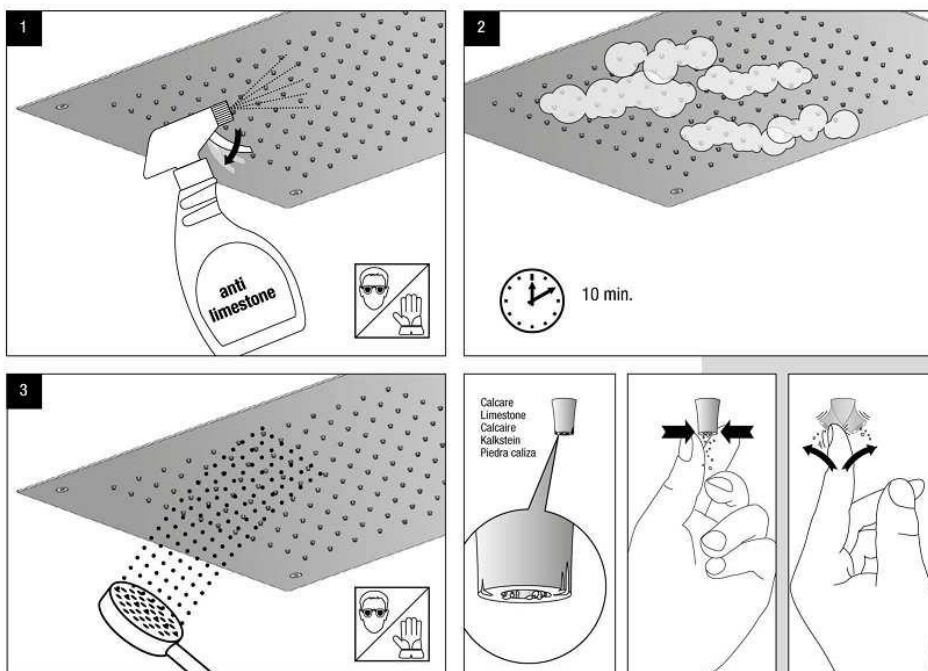

Optional

Bezpečnostní sada

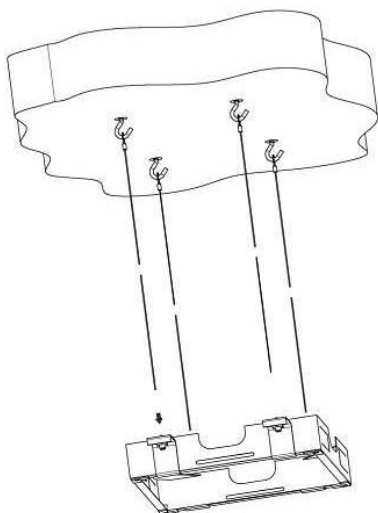

DOVOZCE

SANJET s.r.o. , nám. MUDr. J. Svobody 60 , 285 22 Zruč nad Sázavou

tel.: 327 532 298 fax: 327 532 938 mobil: 603 177 127

<http://www.sanjet.cz> , e-mail: sanjet@sanjet.cz